



# BroaMan

Broadcast Manufactur



## Operating Manual for MUX22

BroaMan device with Optocore® and SANE® integration

© Copyright 2017 All rights reserved

BROAMAN GmbH  
Alte Allee 28  
81245 Munich  
Germany

Page intentionally left blank.

## ***Important Safety Instructions***

- Please read this operating manual carefully.
- Please keep this operating manual in a safe place.
- Heed all warnings.
- Follow all instructions.
- This device may only be used in accordance to the information provided in this operating manual. Ensure that all recommendations, especially the safety recommendations as detailed in this operating manual, are followed before and during the usage of the device.
- Do not use this device near water, for example, in humid or damp rooms.
- Clean only with a dry cloth.
- Do not block or cover any ventilation slits. Install the device in accordance with the operating manual.
- Do not install or place the device near a source of heat such as: radiators, power-amplifiers, or any other heat-producing equipment.
- Protect the power cord from being stepped on, crushed, pinched or damaged in any other way. Pay special attention to plugs and sockets of the device.
- Do not place this device on an unstable table, tripod, cart, etc. The device may fall, causing serious damage to the device.
- The device can be disconnected from the power supply by pulling the plug. These must be freely accessible at all times. The device should be disconnected during lightning storms or when unused for long periods of time.
- The device must be grounded; any disconnection of the grounding is not permitted.
- The internal components of the switched-mode power supplies operate at very high voltages. Coming into contact with them can lead to considerable electric shock, which may result in death.
- Only use attachments specified by the manufacturer.
- This device contains no user serviceable parts: only refer to authorised, qualified service personnel for any servicing.
- Your warranty will be voided if you tamper with the internal components.

## Owner Information

- **Operating Manual**

Please read this manual. If you call for technical support, we will assume that you have already done so. Study the operating manual carefully in order to familiarise yourself with the device and its operation. The operating manual contains important information on proper use of the device.

It cannot be guaranteed that this operating manual will not contain typographical mistakes or misprints. The operating manual is regularly revised and updated.

Modifications, which serve the purpose of technical improvement of the device, may be carried out without prior notification.

- **Transport and Shipping**

Always ensure careful handling of the device. The device should be transported and shipped in shock-absorbing transport cases. If these are not available, we recommend well-padded packaging such as the coated carton in which the device was delivered.

We strongly advise against the use of light weight flight-cases without shock-absorbing rack-in-rack mounting.

- **Operational Environment**

This device can be used in E1, E2, E3, E4, or E5 environments (as listed below) according to the harmonized European standards EN55103-1 and EN55103-2 "Electromagnetic compatibility – Product family standard for audio, video and audio-visual and entertainment lighting control apparatus for professional use"

E1-Residential

E2-Commercial and light industrial

E3-Urban outdoors

E4-Controlled EMC environment e.g. broadcast and TV-studio

E5-Heavy industry

The product is intended for the use in moderate climate.

- **Ventilation**

Do not block or cover any ventilation openings. Install the device in accordance to the operating manual. Allow for sufficient space around the units (at least 200 mm  $\equiv$  7,87" free space behind the rear-panel of the device) and make sure to allow for air circulation near the ventilation openings on both sides of the device. Keep the rear of the rack open during operation. Do not operate the device close to heat emitting equipment, such as power-amplifiers. Leave sufficient space (minimum  $\frac{1}{2}$  RU) between the device and any heat emitting devices housed in the same rack.

A BroaMan MUX22 may be placed on top or beneath other BroaMan products, without a space between the devices for up to 4 adjacent rack spaces.

**Please note:**

Do not populate more than 4 adjacent rack spaces with BroaMan devices.

Maintain 1RU of empty space between each 4 RU of BroaMan devices.

Keep the equipment rack open during operation.

Ensure air circulation around the devices.

Maintain at least 200mm (~8") clearance behind the rear panel of the devices.

- **Water and Moisture etc.**

To prevent fire or shock hazard do not expose the device to direct sunlight, dust, water or rain during operation or storage.

- **Cleaning**

Only use a dry linen cloth to clean the device. If the unit is very dirty, moisten a cloth using a little water and a small amount of household detergent. Never use cleansing agents containing solvents to clean the device.

- **Operating and Storage Temperature**

Operating temperature:  $-20^{\circ}\text{C} \dots 50^{\circ}\text{C} \equiv -4^{\circ}\text{F} \dots 122^{\circ}\text{F}$ ; ensure proper ventilation

Storage temperature:  $-20^{\circ}\text{C} \dots 60^{\circ}\text{C} \equiv -4^{\circ}\text{F} \dots 140^{\circ}\text{F}$

- **Power Supply**

The device can be disconnected from the power supply by unplugging the power cord. The power cords must be freely accessible at all times. The device should be disconnected during lightning storms or when the device is unused for a long period of time.

**Important:**

The switched-mode power supplies operate at very high voltages.

Coming into contact with the power supplies can lead to considerable electric shock, which may result in death.

Never disconnect the main plug by pulling the cable. Always unplug the device.

Power-supply cords should be routed in such a way that they are not likely to be walked on, crushed, pinched, or damaged in any other way. Pay special attention to the plugs and the sockets of the device.

**Important:**

A damaged power cable must be replaced immediately.

The device must be grounded. Disconnecting the ground is strictly prohibited. Ensure that the device is always grounded using the power connector.

Do not cover the ground connection of the power connector with any kind of insulation material!

- **Fuse**

There is no fuse in the device. The power supplies contain circuitry that protects the device from overload.

- **Lightning**

For additional protection of this device during lightning storms, or when it is left unattended and unused for a long period of time, disconnect the power cord. This will prevent damage to the device due to lightning and power line surges. Disconnection from the mains power supply is only possible by disconnecting the power plug from the mains socket.

- **Eye Safety**

This product is a Laser Class 1 product. It complies with IEC 60825-1, FDA 21 CFR 1040.10, and 1040.11.

- **External objects and/or liquids with the device**

Never push objects of any kind into the device through openings in the casing. They may come into contact with dangerous voltage points or short out parts that could result in fire or electric shock. Never spill liquid of any kind on the device.

- **Cables and Accessories**

Only use attachments that are specified by the manufacturer of the device.

Use high quality, properly terminated, cables to connect the device. The device should only be used with optical fibre cables that are specified for use with the devices' optical transceivers and within the specified power budget of the optical transceivers. When not in use, ensure that the optical connectors on the device and the optical fibre cables are covered with the provided caps.

Do not place this device on an unstable table, tripod, cart, etc. The device may fall, which can cause injury and serious damage to the device. Any mounting of the device should follow the manufacturer's instructions, and should use mounting accessories recommended by the manufacturer of the device.

- **Servicing**

Do not attempt to service the device by yourself.

The device contains no user serviceable parts, components or controls. The operation of an opened device is not permitted. Such operation can lead to damage of the device's components due to lack of air-flow through the device.

The device may not be serviced, altered or modified without authorization from Broaman or an Broaman authorized distributor / dealer. Only qualified service personnel may carry out repair and maintenance work on the device. The warranty of the device will be voided if any unauthorized maintenance or repair work has been carried out.

## CE/FCC Conformity

This document confirms that the product MUX22 bearing the CE (Communauté Européenne) label meets all requirements in the EMC directive 2004/108/EG laid down by the Member States Council for adjustment of legal requirements. Furthermore the product complies with the rules and regulations of the low-voltage directive 2006/95/EG and the Restriction of Hazardous Substances Recast Directive 2011/65/EU (RoHS 2). This product bearing the CE label complies with the following standards, ratified by CENELEC (Comité Européen de Normalisation Electrotechnique):

**Electromagnetic compatibility – Product family standard for audio, video, audio-visual and entertainment lighting control apparatus for professional use**

**EN 55103-1, Emission**

**EN 55103-2, Immunity**

**EN 60065, Safety requirements**

### FCC notice

This device complies with Part 15 of the FCC rules. Operation is subject to the following two conditions:

- (1) This device may not cause harmful interference, and
- (2) This device must accept any interference received, including interference that may cause undesired operation.

**NOTE:** This equipment has been tested and found to comply with the limits for a Class A digital device, pursuant to Part 15 of the FCC rules. These limits are designed to provide reasonable protection against harmful interference when the equipment is operated in a commercial environment. This equipment generates, uses and can radiate radio frequency energy and, if not installed and used in accordance with the instruction manual, may cause harmful interference to radio communication. Operation of this equipment in a residential area is likely to cause harmful interference, in which case you will be required to correct the interference at his own expense.

Changes or modifications not expressly approved by Broadcast Manufactur GmbH and Clear-Com, LLC, an HME company could void the user's authority to operate this equipment.

### Industry Canada Compliance Statement

This Class[A] digital device complies with Canadian ICES-003.

### Avis de conformité à la réglementation d'Industrie Canada

Cet appareil numérique de la class[A] est conforme à la norme NMB-003 du Canada.

The authorised declaration and compatibility certification lies with the manufacturer and can be viewed on request. Responsible as manufacturer is:

**Broadcast Manufactur GmbH**, Alte Allee 28, 81245 Munich, Germany

Represented by Marc Brunke, Technical Director

**N.B.** The awarding of the CE label confirms the compliance with legal directives issued for the manufacture and marketing of electronic and electrical devices. As such the CE label is not a "seal of quality" but rather proof that the device bearing the CE label is conform with the electromagnetic compatibility standards laid down in the above named testing regulations.

Munich, 05.06.2014



Marc Brunke

## BroaMan MUX22

Operating Manual

Rev. 2.1

Page intentionally left blank.



## BroaMan MUX22

### Table of Contents

Important Safety Instructions.....	3
Owner Information.....	4
CE/FCC Conformity.....	7
Device Description .....	11
Front Panel.....	12
MUX22 IVT/IC444; IVT/IC422; IVT/IC485; IVT/ICAES .....	12
MUX22 IVT/MADI-OPT; IVT/MADI-BNC .....	14
MUX22 IVT .....	16
MUX22 IVT/IVT.....	18
Rear Panel .....	20
MUX22 IVT/IC422; IVT/IC485; IVT/ICAES .....	20
MUX22 IVT/IC444.....	21
MUX22 IVT/MADI-OPT .....	22
MUX22 IVT/MADI-BNC.....	22
MUX22 IVT .....	24
MUX22 IVT/IVT.....	24
MUX22 with RS422 special serial data interface.....	25
Device Details .....	26
BNC-SDI Ports.....	26
IVT (Intelligent Video Tunnel) Input Module.....	26
IVT (Intelligent Video Tunnel) Output Module.....	26
Fiber Ports .....	26
Multiplexers.....	26
IC422 and IC485 - Intercom Ports .....	26
ICAES - AES3 Duplex Ports .....	26
IC444 - Line Level I/O and GPIO.....	27
FO – four duplex optical MADI ports.....	27
BNC – four duplex optical MADI ports .....	27
Optocore Fiber Optic Connection .....	27
SANE Ports.....	27
RS485, GPIO or RS422 Auxiliary Ports.....	27
Sync.....	28
Optocore Transmission Delay.....	28
Power Supply.....	28
Control.....	28
Connectors and Cables.....	29
SD/HD/3G-SDI Ports .....	29
Optical Connections.....	29
SANE Ports.....	29

## BroaMan MUX22

Operating Manual

Rev. 2.1

Auxiliary Ports – RS485/GPIO/RS422 .....	29
RS232 Connection .....	29
Connector Hood Quality .....	29
USB Connection .....	30
LAN Connection .....	30
Word Clock/Sync Connection .....	30
Power Connection .....	30
Ordering Options .....	30
MUX22 IVT/IC422 .....	30
MUX22 IVT/IC485 .....	31
MUX22 IVT/IC444 .....	31
MUX22 IVT/ICAES .....	32
MUX22 IVT/MADI-OPT .....	32
MUX22 IVT/MADI-BNC .....	33
Connector Pin Out .....	34
Connection Examples GPI/GPO IC444 Module .....	38
Dimensions and Weight .....	40
Dimensions .....	40
Weight .....	40
Warranty and Liability .....	41
Summary of Warranty .....	41
How to Obtain Warranty Service .....	41
Declaration of Liability .....	41
Package Contents .....	42
Company Information .....	43

## Device Description

Congratulations on your purchase of a MUX22 - 3G/HD/SD-SDI electrical-optical converter with integrated Wavelength Division Multiplexer (CWDM/DWDM) and interface to Optocore® and SANE® for joint transport of video, audio and data over a duplex fiber connection. This manual will quickly demonstrate the advantages of the device and help ease your day-to-day workload in the professional audio-visual environment.

BroaMan provides scalable and protocol independent routing, repeating, transport and distribution of multiple professional video, audio and data signals via optical fiber.

BroaMan systems are built from a collection of modules that includes: coaxial and optical I/O, routers, repeaters, and optical multiplexers. Using BroaMan modular building blocks, any system configuration can be realised.

BroaMan systems are specified and built to provide an engineered system solution, tailored to the requirements of the customer. The modular nature of BroaMan paves the way for construction of fully cost optimised systems.

MUX22 is an application engineered electrical-optical/optical-electrical converter and Wavelength Division Multiplexer (WDM) for 3G/HD/SD-SDI signals seamlessly integrating in Optocore® and SANE® digital audio networks. SDI signals are transported asynchronously to provide low latency, whilst audio and data as well as sync signals are transmitted via the synchronous Optocore Network.

MUX22 can be populated with up to four (in a special version without audio/intercom functionality up to 8) dual channel 3G/HD/SD-SDI modules that can convert electrical to optical or optical to electrical signals.

For (optionally redundant) SDI point to point connections, **IVT** with two 3G/HD/SD-SDI BNC inputs or outputs, which will be converted to/from fiber and can be configured redundantly

MUX22 can be ordered with different types of audio/intercom connections.

For ClearCom intercom systems:

**IC422 with 4 Clear-Com** compatible four-wire intercom ports with serial control.

For RTS intercom systems:

**IC485 with 4 RTS** compatible four-wire intercom ports with serial control.

For systems requiring line level I/O and GPIO:

**IC444 with 4 Line Level** inputs and outputs, **4 GPI** in and **4 GPI** out and auxiliary power output.

For AES connectivity (for e.g. AES/EBU based intercoms)

**ICAES with 4 AES3** inputs and outputs.

For MADI connectivity:

**FO with 4 Duplex SC MADI Ports**

**BNC with 4 Bi-directional BNC MADI Ports**

IC422 and IC485 modules provide 4-wire intercom ports with line level audio inputs and outputs along with serial data links on RJ45 connectors for communication between intercom matrices and auxiliary devices. Serial control is routed with the audio, requiring audio to be routed to and from each port in order to establish bi-directional audio and serial communication between matrices, user key-panels and/or interfaces.

Each IC422 and IC485 four-wire intercom port can be used as an independently routed line level input and output using an adaptor from RJ45 to a connector such as XLR.

The ICAES module provides a fully 32-bit transparent AES3 input and output on each RJ45 connector for communication of AES3-based intercom systems or can be used as AES3 input/output with a proper cable adapter.

IC422, IC485 and ICAES RJ45 intercom ports are duplicated with reversed wiring so that either matrices (TO MATRIX) or intercom key-panels (TO PANELS) can be connected to the unit using standard CAT cables, making cabling simple and cost-efficient.

The IC444 module provides line level audio inputs and outputs, GPIO (General Purpose Inputs and Outputs) and auxiliary +5V DC and +12V DC power outputs, to power external circuits, on 37 pin D-Sub connectors. GPIOs are routed with the corresponding audio inputs and outputs, requiring audio to be routed to and from each port in order to establish bi-directional audio and GPIO links.

The FO/BNC MADI I/O module is equipped with four MADI input ports and four MADI output ports, each transmitting or receiving up to 64 audio channels. This amounts to a total number of up to 256 input channels and 256 output channels per device. The interfaces are SC multi/singlemode or dual BNC.

MUX22 is equipped with a built-in redundant power supply with an automatic switchover.

## BroaMan MUX22

Operating Manual

Rev. 2.1

## Front Panel

### MUX22 IVT/IC444; IVT/IC422; IVT/IC485; IVT/ICAES

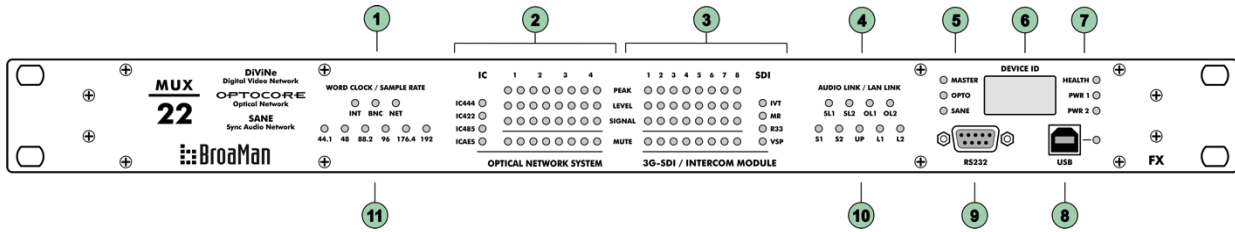

**1 Word Clock LED:** Indicates the selected Sync/Word Clock source:

**INT:** Internal Sync/Word Clock of the device  
**BNC:** External via the BNC SYNC input  
**NET:** Sync/Word Clock received from the Optocore network

**2 Signal Monitor LED for 4 Duplex Audio Channels:**

**IC422:** Four-wire intercom ports with bi-directional RS422 (for Clear-Com)  
**IC485:** Four-wire intercom ports with bi-directional RS485 (for RTS)  
**IC444:** Line Level I/O with GPIO  
**ICAES:** Bi-directional AES3 ports

**PEAK:** Red: Clipping. Input level exceeds the maximum input level of 0dBFS  
**LEVEL:** Yellow: Warning level. Input level exceeds -10dBFS  
**SIGNAL:** Green: Signal present  $\geq$  -60dBFS. Brightness controlled  
**MUTE:** Red: Input: no function; Output: no signal routed to this output

**3 Signal Monitor LED for 8 3G/HD/SDI Channels:**

**IVT:** Intelligent Video Tunnel  
**MR:** currently not used  
**R33:** currently not used  
**VSP:** currently not used

**PEAK:** Red: Optical power exceeds the maximum input level of the receiver  
**LEVEL:** Yellow: Optical power is in proper range and good condition  
**SIGNAL:** Green: Indicates SDI input/output signal presence  
**MUTE:** Red: Optical power is too low, signal is muted

**4 AUDIO LINK LED:**

**SL1:** Communication is established via SANE 1 (rear panel)  
**SL2:** Communication is established via SANE 2 (rear panel)  
**OL1:** Communication is established via Optocore LINK 1 (rear panel)  
**OL2:** Communication is established via Optocore LINK 2 (rear panel)

**5 Master LED:** Indicates the master device in the system  
**OPTO LED:** Optocore communication is established  
**SANE LED:** SANE communication is established

**6 Device ID Display:** The identification number (ID) of the device

## BroaMan MUX22

Operating Manual  
 Rev. 2.1

- 7** **HEALTH LED:** Green: Power supply to the device is working; temperature is within limits  
**PWR 1 LED:** Green: Power supply 1 is receiving power and working  
**PWR 2 LED:** Green: Power supply 2 is receiving power and working
- 8** **USB connector:** USB connection for remote control via PC  
**USB LED:** Green: Indicates data activity
- 9** **RS232 connector:** RS232 (D-Sub-9) connection for remote control and firmware updates via PC
- 10** **LAN LINK LED:**  
**S1:** Ethernet communication is established via SANE 1 (rear panel)  
**S2:** Ethernet communication is established via SANE 2 (rear panel)  
**UP:** There is another device with an enabled Ethernet port on the network  
**L1:** Ethernet communication is established via LAN 1 (rear panel)  
**L2:** Ethernet communication is established via LAN 2 (rear panel)
- 11** **Sample rate LED:** Yellow: 44.1 / 48 / 88.2 / 96 / 176.4 / 192 kHz

## MUX22 IVT/MADI-OPT; IVT/MADI-BNC

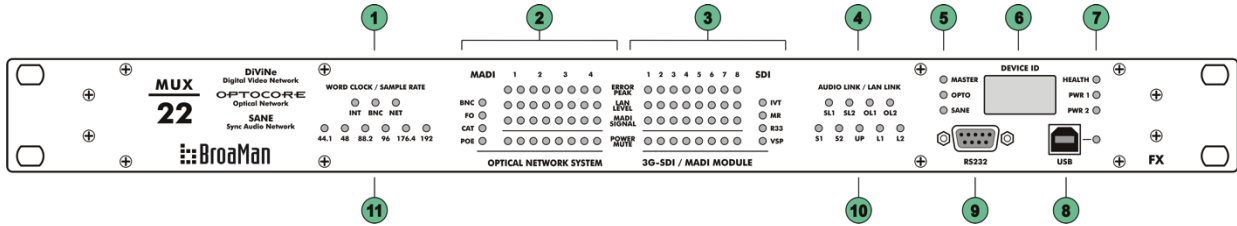

- 1 Word Clock LED:** Indicates the selected Sync/Word Clock source:
- INT:** Internal Sync/Word Clock of the device  
**BNC:** External via the BNC SYNC input  
**NET:** Sync/Word Clock received from the Optocore network
- 2 Signal Monitor LED for 4 Duplex MADI:**
- BNC:** Four Dual Coaxial MADI  
**FO:** Four Bi-Directional Optical SC MADI  
**CAT:** Future option  
**POE:** Future option
- ERROR:** Red: Error with incoming MADI signal  
**LAN:** Yellow: Ethernet communication present  
**MADI:** Green: MADI Signal present  
**POWER:** Red: Future Option
- 3 Signal Monitor LED for 8 3G/HD/SDI Channels:**
- IVT:** Intelligent Video Tunnel  
**MR:** currently not used  
**R33:** currently not used  
**VSP:** currently not used
- PEAK:** Red: Optical power exceeds the maximum input level of the receiver  
**LEVEL:** Yellow: Optical power is in proper range and good condition  
**SIGNAL:** Indicates SDI input/output signal presence  
**MUTE:** Red: Optical power is too low, signal is muted
- 4 LINK LED:**
- SL1:** Communication is established via SANE 1 (rear panel)  
**SL2:** Communication is established via SANE 2 (rear panel)  
**OL1:** Communication is established via Optocore LINK 1 (rear panel)  
**OL2:** Communication is established via Optocore LINK 2 (rear panel)
- 5 Master LED:** Indicates the master device in the system  
**OPTO LED:** Optocore communication is established  
**SANE LED:** SANE communication is established
- 6 Device ID Display:** The identification number (ID) of the device
- 7 HEALTH LED:** Green: Power supply to the device is working; temperature is within limits  
**PWR 1 LED:** Green: Power supply 1 is receiving power and working  
**PWR 2 LED:** Green: Power supply 2 is receiving power and working

## BroaMan MUX22

Operating Manual  
 Rev. 2.1

- 8** **USB connector:** USB connection for remote control via PC  
**USB LED:** Green: Indicates data activity
- 9** **RS232 connector:** RS232 (D-Sub-9) connection for remote control and firmware updates via PC
- 10** **LAN LINK LED:**
- S1:** Ethernet communication is established via SANE 1 (rear panel)
  - S2:** Ethernet communication is established via SANE 2 (rear panel)
  - UP:** There is another device with an enabled Ethernet port on the network
  - L1:** Ethernet communication is established via LAN 1 (rear panel)
  - L2:** Ethernet communication is established via LAN 2 (rear panel)
- 11** **Sample rate LED:** Yellow: 44.1 / 48 / 88.2 / 96 / 176.4 / 192 kHz

## MUX22 IVT

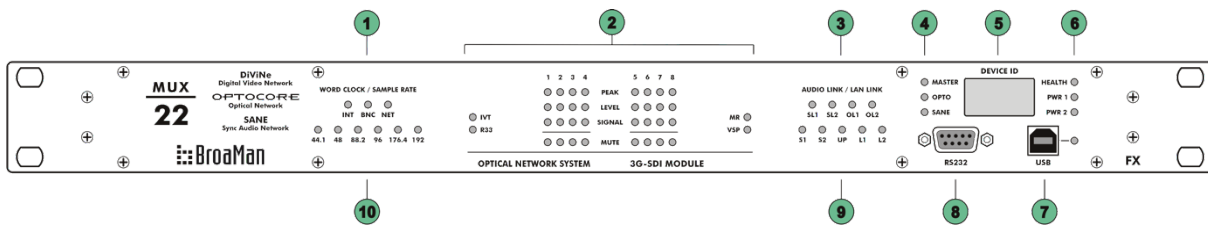

- 1 Word Clock LED:** Indicates the selected Sync/Word Clock source:

**INT:** Internal Sync/Word Clock of the device  
**BNC:** External via the BNC SYNC input  
**NET:** Sync/Word Clock received from the Optocore network
- 2 Signal Monitor LED for 8 3G/HD/SDI Channels:**

**IVT:** Intelligent Video Tunnel  
**MR:** currently not used  
**R33:** currently not used  
**VSP:** currently not used

**PEAK:** Red: Optical power exceeds the maximum input level of the receiver  
**LEVEL:** Yellow: Optical power is in proper range and good condition  
**SIGNAL:** Indicates optical input/output power by brightness  
**MUTE:** Red: Optical power is too low, signal is muted
- 3 LINK LED:**

**SL1:** Communication is established via SANE 1 (rear panel)  
**SL2:** Communication is established via SANE 2 (rear panel)  
**OL1:** Communication is established via Optocore LINK 1 (rear panel)  
**OL2:** Communication is established via Optocore LINK 2 (rear panel)
- 4 Master LED:** Indicates the master device in the system  
**OPTO LED:** Optocore communication is established  
**SANE LED:** SANE communication is established
- 5 Device ID Display:** The identification number (ID) of the device
- 6 HEALTH LED:** Green: Power supply to the device is working; temperature is within limits  
**PWR 1 LED:** Green: Power supply 1 is receiving power and working  
**PWR 2 LED:** Green: Power supply 2 is receiving power and working
- 7 USB connector:** USB connection for remote control via PC  
**USB LED:** Green: Indicates data activity
- 8 RS232 connector:** RS232 (D-Sub-9) connection for remote control and firmware updates via PC

## BroaMan MUX22

Operating Manual  
 Rev. 2.1



- 9 **LAN LINK LED:**
- S1:** Ethernet communication is established via SANE 1 (rear panel)
  - S2:** Ethernet communication is established via SANE 2 (rear panel)
  - UP:** There is another device with an enabled Ethernet port on the network
  - L1:** Ethernet communication is established via LAN 1 (rear panel)
  - L2:** Ethernet communication is established via LAN 2 (rear panel)
- 10 **Sample rate LED:** Yellow: 44.1 / 48 / 88.2 / 96 / 176.4 / 192 kHz

## MUX22 IVT/IVT

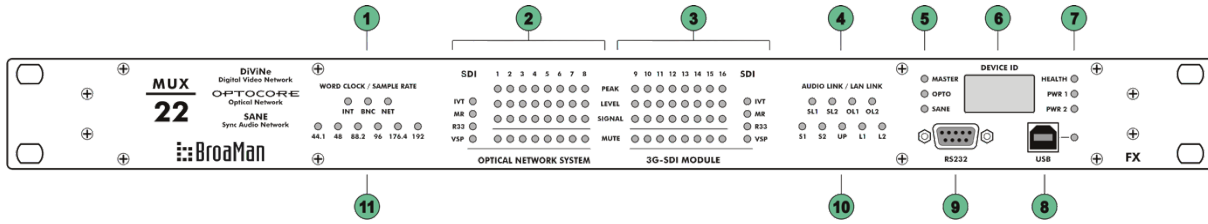

- 1 Word Clock LED:** Indicates the selected Sync/Word Clock source:

  - INT:** Internal Sync/Word Clock of the device
  - BNC:** External via the BNC SYNC input
  - NET:** Sync/Word Clock received from the Optocore network
  
- 2 3 Signal Monitor LED for 16 3G/HD/SDI Channels:**

  - IVT:** Intelligent Video Tunnel
  - MR:** currently not used
  - R33:** currently not used
  - VSP:** currently not used
  
  - PEAK:** Red: Optical power exceeds the maximum input level of the receiver
  - LEVEL:** Yellow: Optical power is in proper range and good condition
  - SIGNAL:** Green: Indicates optical input/output power by brightness
  - MUTE:** Red: Optical power is too low, signal is muted
  
- 4 LINK LED:**

  - SL1:** Communication is established via SANE 1 (rear panel)
  - SL2:** Communication is established via SANE 2 (rear panel)
  - OL1:** Communication is established via Optocore LINK 1 (rear panel)
  - OL2:** Communication is established via Optocore LINK 2 (rear panel)
  
- 5 Master LED:** Indicates the master device in the system

  - OPTO LED:** Optocore communication is established
  - SANE LED:** SANE communication is established
  
- 6 Device ID Display:** The identification number (ID) of the device
  
- 7 HEALTH LED:** Green: Power supply to the device is working; temperature is within limits

  - PWR 1 LED:** Green: Power supply 1 is receiving power and working
  - PWR 2 LED:** Green: Power supply 2 is receiving power and working
  
- 8 USB connector:** USB connection for remote control via PC

  - USB LED:** Green: Indicates data activity
  
- 9 RS232 connector:** RS232 (D-Sub-9) connection for remote control and firmware updates via PC
  
- 10 LAN LINK LED:**

  - S1:** Ethernet communication is established via SANE 1 (rear panel)

## BroaMan MUX22

Operating Manual  
Rev. 2.1

**S2:** Ethernet communication is established via SANE 2 (rear panel)  
**UP:** There is another device with an enabled Ethernet port on the network  
**L1:** Ethernet communication is established via LAN 1 (rear panel)  
**L2:** Ethernet communication is established via LAN 2 (rear panel)

**11** **Sample rate LED:** Yellow: 44.1 / 48 / 88.2 / 96 / 176.4 / 192 kHz

## Rear Panel

### MUX22 IVT/IC422; IVT/IC485; IVT/ICAES

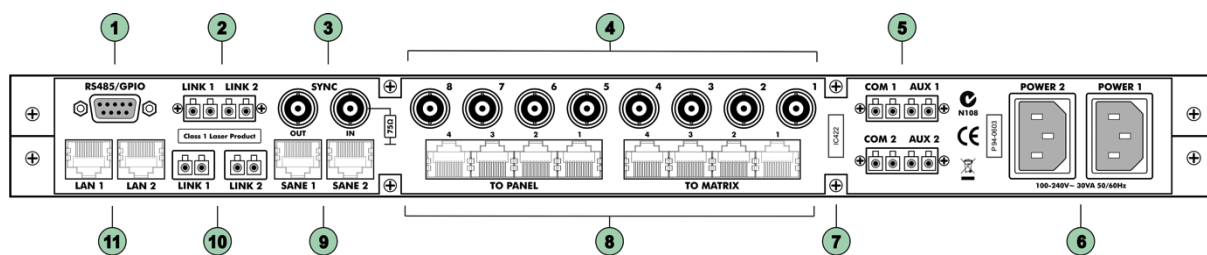

- 1 RS485/GPIO:** 4 x RS485 (D-Sub-9) or GPIO (D-Sub-15) auxiliary port for data transmission
- 2 WDM ports LINK1/2:** CWDM or DWDM multiplexer Input/Output for Optocore duplex fiber connection (LINK1 and LINK2). Can be used for external fiber devices such as Ethernet switches (see AUX1/2).
- 3 SYNC In:** Tri-/Bi-Level Sync or Word Clock (software selectable) input allowing synchronisation of Optocore devices/network and sync signal distribution via the Optocore network from an external Sync/Word Clock source
- SYNC Out** Tri-/Bi-Level Sync or Word Clock output for synchronization of external devices
- 4 Coaxial ports 1-8:** Can be equipped with:
  - 3G/HD/SD-SDI (reclocked) inputs in pairs of two
  - 3G/HD/SD-SDI (reclocked) outputs in pairs of two
The coaxial ports are connected internally to SFP fiber transceivers that feed the specified CWDM or DWDM multiplexers.
- 5 WDM port COM1:** Combined duplex fiber port of internal WDM, CWDM or DWDM No.1  
**WDM port COM2:** Combined duplex fiber port of internal WDM, CWDM or DWDM No.2  
**WDM port AUX1:** Auxiliary duplex fiber port of internal WDM, CWDM or DWDM module No.1, provides connectivity for external fiber devices such as Gigabit Ethernet switches or any other third party optical connection.  
**WDM port AUX2:** Auxiliary duplex fiber port of internal WDM, CWDM or DWDM module No.2, provides connectivity for external fiber devices such as Gigabit Ethernet switches or any other third party optical connection.
- 6 POWER 1 and 2:** AC input for power supplies 1 and 2 (100 ... 240 V).  
Optionally: DC input for power supply 1 and 2 with 4 pin XLR Male (8 ...18V)
- 7 Device Label:** Audio/intercom card type and serial number of the device
- 8 TO PANEL:** RJ45 4-wire/AES intercom ports wired for connection to key-panels or interfaces  
**TO MATRIX:** RJ45 4-wire/AES intercom ports wired for connection to matrices
- 9 SANE 1:** SANE RJ-45 interface for audio transmission and 100 Mbit Ethernet  
**SANE 2:** SANE RJ-45 interface for audio transmission and 100 Mbit Ethernet
- 10 LINK 1:** Full-duplex, full bandwidth LC-type optical interface for Optocore transmission (SFP transceiver – type depending on a specification)  
**LINK 2:** Full-duplex, full bandwidth LC-type optical interface for Optocore transmission (SFP transceiver – type depending on a specification)
- 11 LAN 1:** 100 Mbit RJ-45 Ethernet interface  
**LAN 2:** 100 Mbit RJ-45 Ethernet interface

## BroaMan MUX22

Operating Manual  
Rev. 2.1

## MUX22 IVT/IC444

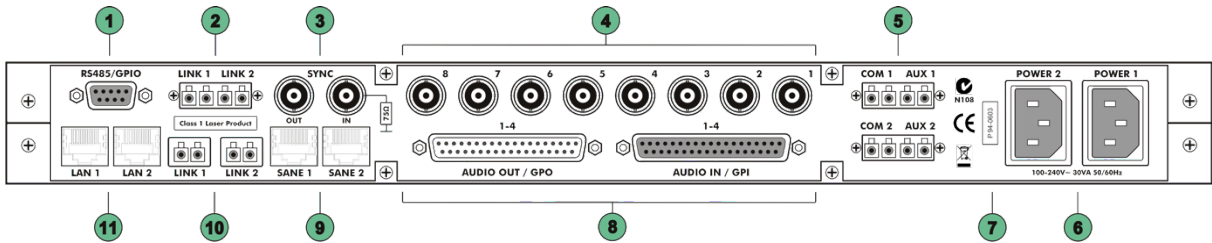

- 1 RS485/GPIO:** 4 x RS485 (D-Sub-9) or GPIO (D-Sub-15) auxiliary port for data transmission
- 2 WDM ports LINK1/2:** CWDM or DWDM multiplexer Input/Output for Optocore duplex fiber connection (LINK1 and LINK2). Can be used for external fiber devices such as Ethernet switches (see AUX1/2).
- 3 SYNC In:** Tri-/Bi-Level Sync or Word Clock (software selectable) input allowing synchronisation of Optocore devices/network and sync signal distribution via the Optocore network from an external Sync/Word Clock source

**SYNC Out** Tri-/Bi-Level Sync or Word Clock output for synchronization of external devices
- 4 Coaxial ports 1-8:** Can be equipped with:

  - 3G/HD/SD-SDI (reclocked) inputs in pairs of two
  - 3G/HD/SD-SDI (reclocked) outputs in pairs of two

The coaxial ports are connected internally to SFP fiber transceivers that feed the specified CWDM or DWDM multiplexers.
- 5 WDM port COM1:** Combined duplex fiber port of internal WDM, CWDM or DWDM No.1

**WDM port COM2:** Combined duplex fiber port of internal WDM, CWDM or DWDM No.2

**WDM port AUX1:** Auxiliary duplex fiber port of internal WDM, CWDM or DWDM module No.1, provides connectivity for external fiber devices such as Gigabit Ethernet switches or any other third party optical connection.

**WDM port AUX2:** Auxiliary duplex fiber port of internal WDM, CWDM or DWDM module No.2, provides connectivity for external fiber devices such as Gigabit Ethernet switches or any other third party optical connection.
- 6 POWER 1 and 2:** AC input for power supplies 1 and 2 (100 ... 240 V).  
Optionally: DC input for power supply 1 and 2 with 4 pin XLR Male (8 ... 18V)
- 7 Device Label:** Audio/intercom card type and serial number of the device
- 8 AUDIO IN / GPI:** 4 Line Level audio inputs, 4 General Purpose Inputs, auxiliary power +5V, +12V

**AUDIO OUT / GPO:** 4 Line Level audio outputs, 4 General Purpose Inputs, auxiliary power +5V, +12V
- 9 SANE 1:** SANE RJ-45 interface for audio transmission and 100 Mbit Ethernet

**SANE 2:** SANE RJ-45 interface for audio transmission and 100 Mbit Ethernet
- 10 LINK 1:** Full-duplex, full bandwidth LC-type optical interface for Optocore transmission (SFP transceiver – type depending on a specification)

**LINK 2:** Full-duplex, full bandwidth LC-type optical interface for Optocore transmission (SFP transceiver – type depending on a specification)
- 11 LAN 1:** 100 Mbit RJ-45 Ethernet interface

**LAN 2:** 100 Mbit RJ-45 Ethernet interface

## BroaMan MUX22

Operating Manual  
Rev. 2.1

## MUX22 IVT/MADI-OPT

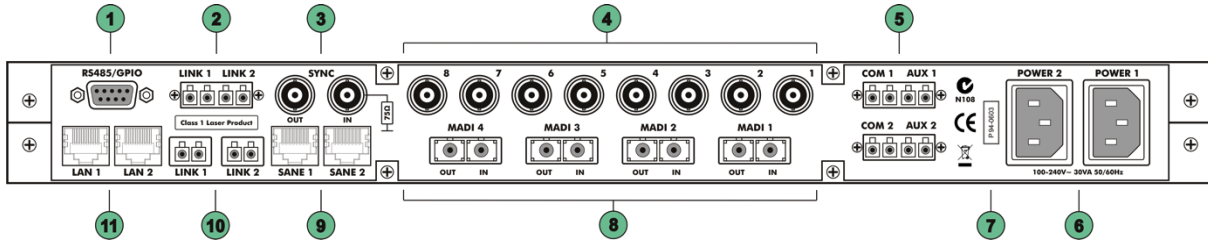

## MUX22 IVT/MADI-BNC

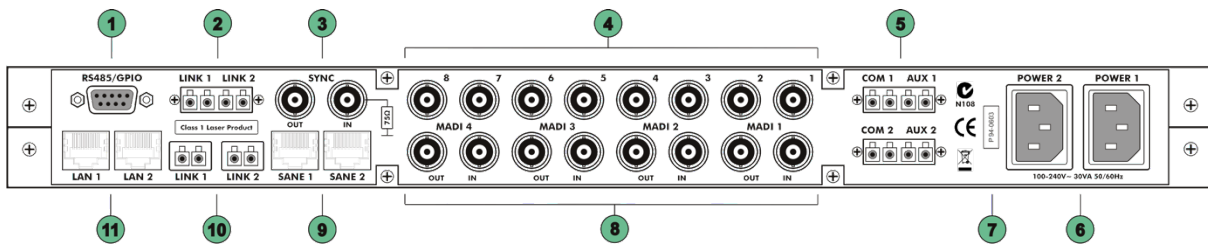

- 1 RS485/GPIO:** 4 x RS485 (D-Sub-9) or GPIO (D-Sub-15) auxiliary port for data transmission
- 2 WDM ports LINK1/2:** CWDM or DWDM multiplexer Input/Output for Optocore duplex fiber connection (LINK1 and LINK2). Can be used for external fiber devices such as Ethernet switches (see AUX1/2).
- 3 SYNC In:** Tri-/Bi-Level Sync or Word Clock (software selectable) input allowing synchronisation of Optocore devices/network and sync signal distribution via the Optocore network from an external Sync/Word Clock source

**SYNC Out** Tri-/Bi-Level Sync or Word Clock output for synchronization of external devices
- 4 Coaxial ports 1-8:** Can be equipped with:

  - 3G/HD/SD-SDI (reclocked) inputs in pairs of two
  - 3G/HD/SD-SDI (reclocked) outputs in pairs of two

The coaxial ports are connected internally to SFP fiber transceivers that feed the specified CWDM or DWDM multiplexers.
- 5 WDM port COM1:** Combined duplex fiber port of internal WDM, CWDM or DWDM No.1  
**WDM port COM2:** Combined duplex fiber port of internal WDM, CWDM or DWDM No.2  
**WDM port AUX1:** Auxiliary duplex fiber port of internal WDM, CWDM or DWDM module No.1, provides connectivity for external fiber devices such as Gigabit Ethernet switches or any other third party optical connection.  
**WDM port AUX2:** Auxiliary duplex fiber port of internal WDM, CWDM or DWDM module No.2, provides connectivity for external fiber devices such as Gigabit Ethernet switches or any other third party optical connection.
- 6 POWER 1 and 2:** AC input for power supplies 1 and 2 (100 ... 240 V).  
 Optionally: DC input for power supply 1 and 2 with 4 pin XLR Male (8 ... 18V)
- 7 Device Label:** Serial number of the device
- 8 MADI PORTS:**

**MADI-OPT**  
 4 x SC multi/single-mode optical MADI inputs and  
 4 x SC multi/single-mode optical MADI outputs

**MADI-BNC**  
 4 x BNC coax MADI inputs and  
 4 x BNC coax MADI outputs

## BroaMan MUX22

Operating Manual  
 Rev. 2.1

- 
- 9 **SANE 1:** SANE RJ-45 interface for audio transmission and 100 Mbit Ethernet
  - 9 **SANE 2:** SANE RJ-45 interface for audio transmission and 100 Mbit Ethernet
  - 10 **LINK 1:** Full-duplex, full bandwidth LC-type optical interface for Optocore transmission (SFP transceiver – type depending on a specification)
  - LINK 2:** Full-duplex, full bandwidth LC-type optical interface for Optocore transmission (SFP transceiver – type depending on a specification)
  - 11 **LAN 1:** 100 Mbit RJ-45 Ethernet interface
  - 11 **LAN 2:** 100 Mbit RJ-45 Ethernet interface

## MUX22 IVT

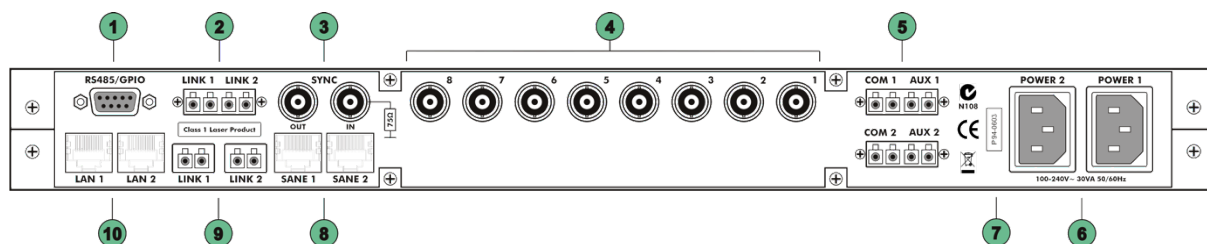

## MUX22 IVT/IVT

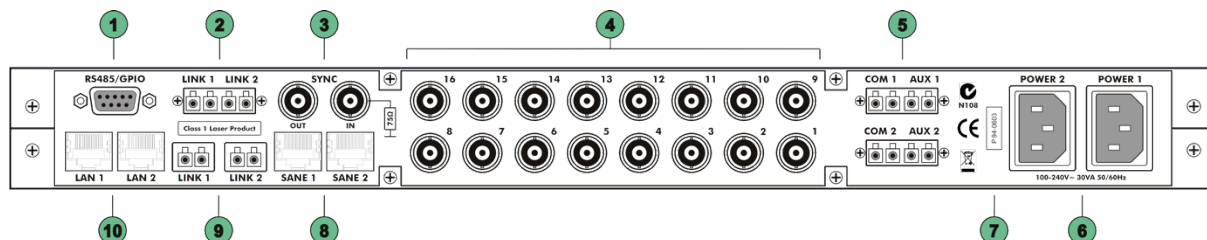

- 1 RS485/GPIO:** 4 x RS485 (D-Sub-9) or GPIO (D-Sub-15) auxiliary port for data transmission
- 2 WDM ports LINK1/2:** CWDM or DWDM multiplexer Input/Output for Optocore duplex fiber connection (LINK1 and LINK2). Can be used for external fiber devices such as Ethernet switches (see AUX1/2).
- 3 SYNC In:** Tri-/Bi-Level Sync or Word Clock (software selectable) input allowing synchronisation of Optocore devices/network and sync signal distribution via the Optocore network from an external Sync/Word Clock source

**SYNC Out** Tri-/Bi-Level Sync or Word Clock output for synchronization of external devices
- 4 Coaxial ports 1-16:** Can be equipped with:

  - 3G/HD/SD-SDI (reclocked) inputs in pairs of two
  - 3G/HD/SD-SDI (reclocked) outputs in pairs of two

The coaxial ports are connected internally to SFP fiber transceivers that feed the specified CWDM or DWDM multiplexers.
- 5 WDM port COM1:** Combined duplex fiber port of internal WDM, CWDM or DWDM No.1  
**WDM port COM2:** Combined duplex fiber port of internal WDM, CWDM or DWDM No.2  
**WDM port AUX1:** Auxiliary duplex fiber port of internal WDM, CWDM or DWDM module No.1, provides connectivity for external fiber devices such as Gigabit Ethernet switches or any other third party optical connection.  
**WDM port AUX2:** Auxiliary duplex fiber port of internal WDM, CWDM or DWDM module No.2, provides connectivity for external fiber devices such as Gigabit Ethernet switches or any other third party optical connection.
- 6 POWER 1 and 2:** AC input for power supplies 1 and 2 (100 ... 240 V).  
 Optionally: DC input for power supply 1 and 2 with 4 pin XLR Male (8 ... 18V)
- 7 Device Label:** Serial number of the device
- 8 MADI PORTS:**

**MADI-OPT**  
 4 x SC multi/single-mode optical MADI inputs and  
 4 x SC multi/single-mode optical MADI outputs

**MADI-BNC**  
 4 x BNC coax MADI inputs and  
 4 x BNC coax MADI outputs

## BroaMan MUX22

Operating Manual  
 Rev. 2.1



- 9 **SANE 1:** SANE RJ-45 interface for audio transmission and 100 Mbit Ethernet
- SANE 2:** SANE RJ-45 interface for audio transmission and 100 Mbit Ethernet
- 10 **LINK 1:** Full-duplex, full bandwidth LC-type optical interface for Optocore transmission (SFP transceiver – type depending on a specification)
- LINK 2:** Full-duplex, full bandwidth LC-type optical interface for Optocore transmission (SFP transceiver – type depending on a specification)
- 11 **LAN 1:** 100 Mbit RJ-45 Ethernet interface
- LAN 2:** 100 Mbit RJ-45 Ethernet interface

### MUX22 with RS422 special serial data interface

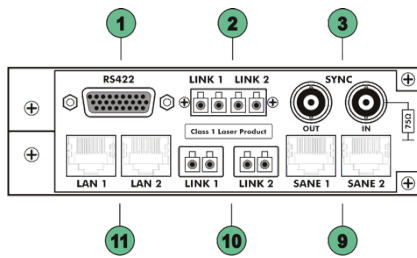

*Special serial data RS422 interface is available on request with all Mux22 versions.*

- 1 **RS422:** 4 x RS422 bi-directional (HD-Sub-26) auxiliary port for data transmission
- 2 **WDM ports LINK1/2:** CWDM or DWDM multiplexer Input/Output for Optocore duplex fiber connection (LINK1 and LINK2). Can be used for external fiber devices such as Ethernet switches (see AUX1/2).
- 3 **SYNC In:** Tri-/Bi-Level Sync or Word Clock (software selectable) input allowing synchronisation of Optocore devices/network and sync signal distribution via the Optocore network from an external Sync/Word Clock source
- SYNC Out** Tri-/Bi-Level Sync or Word Clock output for synchronization of external devices
- 9 **SANE 1:** SANE RJ-45 interface for audio transmission and 100 Mbit Ethernet
- SANE 2:** SANE RJ-45 interface for audio transmission and 100 Mbit Ethernet
- 10 **LINK 1:** Full-duplex, full bandwidth LC-type optical interface for Optocore transmission (SFP transceiver – type depending on a specification)
- LINK 2:** Full-duplex, full bandwidth LC-type optical interface for Optocore transmission (SFP transceiver – type depending on a specification)
- 11 **LAN 1:** 100 Mbit RJ-45 Ethernet interface
- LAN 2:** 100 Mbit RJ-45 Ethernet interface

## BroaMan MUX22

Operating Manual  
Rev. 2.1

## Device Details

### BNC-SDI Ports

MUX22 can be factory fitted with 0-4 (in a special version up to 8) dual-channel video ports, which are specified at the time of ordering. Each port can be equipped with a high quality BNC connector, providing 3G/HD/SD-SDI connectivity.

Two types of dual 3G/HD/SD-SDI modules are available for MUX22:

- IVT Input Module: Two 3G/HD/SD-SDI BNC reclocked inputs (see description below)
- IVT Output Module: Two 3G/HD/SD-SDI BNC reclocked outputs (see description below)

OPTOCORE CONTROL SOFTWARE monitors signal quality and strength.

### IVT (Intelligent Video Tunnel) Input Module

Two 3G/HD/SD-SDI inputs (BNC) with equalizer, reclocker and two dual fiber output ports. The fiber ports can be fitted with one dual SFP transmitter for non-redundant transmission or two dual SFP transmitters for redundant transmission. Redundancy is available only in a point-to-point connection between two MUX22 devices. The fiber transmitters are internally connected to built-in CWDM/DWDM modules.

### IVT (Intelligent Video Tunnel) Output Module

Two 3G/HD/SD-SDI outputs (BNC) with reclocker and two dual fiber input ports. The fiber ports can be fitted with one dual SFP receiver for non-redundant reception or two dual SFP receivers for redundant reception. Redundancy is available only in a point-to-point connection between two MUX22 devices. The fiber receivers are internally connected to built-in CWDM/DWDM modules.

### Fiber Ports

Video signals from/to 3G/HD/SD-SDI coaxial interfaces and audio/data signals from the built-in Optocore module are terminated with SFP fiber ports.

All SFP video fiber ports in a MUX22 device are internally connected to CWDM or DWDM passive multiplexing module(s) as required for the application. Two external duplex fiber ports (labelled LINK1 and LINK2) should be used for the external connection of Optocore fiber links to the built-in CWDM/DWDM module. External auxiliary connections (labelled AUX1 and AUX2) to the multiplexer module(s) can be specified for the connection to an external device such as a Gigabit Ethernet switch. COM1 and COM2 ports transmit/receive the combined signals from/to 2 (redundant) CWDM/DWDM modules. All fiber ports are equipped with LC connectors. In case of MUX22 IVT/IVT each of COM1 and COM2 carry half of video channels, one of AUX and one of LINK.

### Multiplexers

The device is equipped with WDM module(s). CWDM (Coarse Wavelength Division Multiplexing) and DWDM (Dense Wavelength Division Multiplexing) modules are available and will be configured by the manufacturer to the customer's needs. For each SDI signal one wavelength of the WDM module is used, whilst all audio, data and sync signals are transmitted on the same wavelength utilising Optocore protocol.

Additional auxiliary fiber optic connections (tunnels) can be provided for the connection of third party equipment (e.g. Ethernet switches) on customer's request.

### IC422 and IC485 - Intercom Ports

Each 4-wire intercom port is complete with a line level input, line level output and a bi-directional RS422 or RS485 (device specific) serial communication link, allowing seamless integration with ClearCom or RTS intercom systems, on a single RJ45 connector.

The intercom ports are duplicated with a reversed pin out (TO MATRIX and TO PANEL) to allow connections to intercom matrix frames, user key-panels and interfaces using straight Cat5 cables.

### ICAES - AES3 Duplex Ports

Each duplex port provides one fully 32-bit transparent AES3 input and output on a single RJ45 connector, allowing seamless integration with AES-based intercom systems. Intercom matrix and MUX22 devices need to be

## BrooMan MUX22

Operating Manual

Rev. 2.1

synchronise to the same system clock.

#### **IC444 - Line Level I/O and GPIO**

The IC444 module is populated with one 37-pin male and one 37 pin female D-Sub connector. The female connector has 4 line level inputs and 4 optically isolated General Purpose Inputs (GPI). The male connector has 4 line level outputs 4 General Purpose Outputs (GPO) with relay. Auxiliary +12V DC and +5V DC power is available on both connectors, allowing up to 100mA of current to be drawn from each IC444 module. GPIs can be driven by external power ( $\geq +3V$  to  $\leq +48V$  DC). The GPO relays tolerate  $\leq 30V/0,3A$  AC or DC resistive load.

#### **FO – four duplex optical MADi ports**

The FO MADi I/O module is equipped with four MADi input ports and four MADi output ports, each transmitting or receiving up to 64 audio channels. This amounts to a total number of up to 256 input channels and 256 output channels per device. The interfaces are SC multi/singlemode. Each of port can be set to one of the MADi standard. Both AES10-1991(56 channel) and AES10-2003(64 channel) can be set independently for each input and output port.

#### **BNC – four duplex optical MADi ports**

The BNC MADi I/O module is equipped with four MADi input ports and four MADi output ports, each transmitting or receiving up to 64 audio channels. This amounts to a total number of up to 256 input channels and 256 output channels per device. The interfaces are BNC coax. Each of port can be set to one of the MADi standard. Both AES10-1991(56 channel) and AES10-2003(64 channel) can be set independently for each input and output port.

#### **Optocore Fiber Optic Connection**

The device is equipped with an Optocore FX communication module, which is used for audio and data transport as well as system control of MUX22. The OPTOCORE® OPTICAL DIGITAL NETWORK SYSTEM utilizes Time Division Multiplex technology (TDM) with a Fiber Channel based 8B10B-NRZI-coding. Static time slots guarantee a synchronous transmission of all channels, at all times, without the use of dynamic bandwidth. All signals connected to the intercom, audio, word clock/sync and auxiliary ports of the device are transmitted simultaneously on one fiber while the second fiber of the LINK-Interface receives data from the network. The second LINK-Interface pair is identical to the first one, and can optionally be used for the OPTOCORE® network redundancy.

#### **SANE Ports**

The device is equipped with two RJ45 200MBit SANE Ports, capable of transmitting 64 channels of synchronous audio and 100MBit Ethernet.

#### **RS485, GPIO or RS422 Auxiliary Ports**

The manufacturer can equip the auxiliary ports with either four RS485/422 interfaces on a standard D-Sub 9-pin connector or four GPI inputs and outputs on a high density D-Sub 15-pin connector. Customer specifies the connection type at the time of order.

RS485 port with D-Sub 9-pin connector enables the use of a wide range of bi-directional and unidirectional standards, such as RS485 and CAN-Bus (both bi-directional, CAN-Bus requires special firmware version) or RS422, DMX and MIDI (unidirectional). The ports automatically sense whether they are sending or receiving control data. The ports and their destinations are configured in the OPTOCORE CONTROL software. It is possible to configure multiple drop-off connections.

The HD-Sub 15-pin connector provides four electronically isolated General Purpose Interface inputs (GPI) and four General Purpose Interface outputs (GPO). The ports and their destinations are configured in the OPTOCORE CONTROL software. It is possible to configure multiple drop-off connections.

RS422 port with HD-SUB-26-pin connector enables the use of a wide range of bi-directional and unidirectional RS422. The ports and their destinations are configured in the OPTOCORE CONTROL software. It is possible to configure multiple drop-off connections. Each of interface inputs and outputs are independent and different boun-rate signals can be connected.

## **BroaMan MUX22**

Operating Manual

Rev. 2.1

## Sync

MUX22 is equipped with a Sync board enabling software configurable Word Clock or Bi-/Tri-Level Sync inputs and outputs. Any device on the network can act as master of the network and distribute any type of Word Clock/Bi-Tri-Level Sync signal to networked BroaMan, Optocore or SANE devices.

The user can decide whether to lock the BroaMan device and system to the external source or to the internal sync generated in the device. The user can retrieve the Word Clock signal from incoming Video Sync, or regenerate the Sync signal locked with the Word Clock.

The Sync module was created to meet the rigorous Word Clock specifications and keep all audio and data signals in lock, as well as providing sync signals for external video devices.

OPTOCORE CONTROL SOFTWARE allows the selection of the provided synchronization signal which will be outputted on the SYNC output (possible selections are Word Clock, Black Burst, Tri-Level Sync). It is also possible to adjust the sync signal in steps of single pixels and to terminate the input.

## Optocore Transmission Delay

The Optocore system delay, including the matrix, is a fixed 41,6  $\mu\text{s}$  @ 48 kHz for all channels. The additional transport delay per Optocore unit on the network (<200 ns) is insignificant in comparison. Overall system delay is dependent on the converters used and the length of network cables in the system. Assuming 'normal' cable lengths of <700 m per link, the additional delay is considered marginal. The transmission delay is constant between any points in the network.

## Power Supply

The device is equipped with a redundant power supply. If the primary power supply were to fail, due to disruption of the power source or in the case of a power supply malfunction, the device will automatically switch over to the redundant power supply. In order to make the power supply to the device redundant, both power inputs must be connected to the mains supply, if possible to different phases, circuits, or even better, having one of the power supplies connected to an uninterrupted power supply (UPS).

The power supplies operate with mains voltage of 100 ... 240 V and frequency of 50 ... 60 Hz. The device can be used throughout the world without any modifications or transformers.

### Please note:

The switched-mode power supplies operate at very high voltages! Coming into contact with the power supplies can lead to considerable electric shock, which may result in death! To prevent electric shocks, do not remove any covers of the device!

## Control

BroaMan devices can be controlled and troubleshot via Optocore Control Software. All system and device parameters can be configured using the Optocore Control software.

The system can be configured and controlled centrally from one device over the Optocore network, with the exception of the initial configuration of the unique identifier (ID) of the device. User can use a PC computer with one of the control interfaces – Ethernet, USB or RS232.

The Optocore Control software is capable of running multiple instances on the same PC or by using the Optocore Control software's Client/Server mode.

### Please note:

It is possible to utilise 3<sup>rd</sup> party control software or hardware platform to control BroaMan devices. Please contact BroaMan for details.

### Please note:

Please refer to the "Optocore Quick Start Guide" for system configuration and setup (<http://www.optocore.com/>).

## BroaMan MUX22

Operating Manual

Rev. 2.1

## Connectors and Cables

### SD/HD/3G-SDI Ports

Use 75  $\Omega$  coaxial cable with BNC connectors. The cable and connectors used should comply with the digital SD/HD/3G-SDI transmission standards. The maximum cable length is dependent on the bandwidth of the signal (SD, HD or 3G) and the specifications and quality of the cable and connectors.

### Optical Connections

Each MUX22 features internal and external fiber connections. The number of connections depends on the application and will be customized at the time of manufacturing. Each electrical 3G/HD/SD-SDI channel is converted into a different wavelength using internal SFP transceivers and WDM modules.

#### For video applications:

Standard single mode transmitters can be used for applications requiring cable lengths of up to 10 km. For longer cable runs transmitters with higher output power are available (max. cable length without reclocking the signal is 80km), please contact the BroaMan technical team for requests.

The total optical loss should be less than 6dB between transmitter and receiver.

#### For Optocore network:

Multimode or singlemode transceivers are available for the externally accessible Optocore SFP ports and can be changed by the user. Maximum cable length for multimode is 700m, for singlemode 80km. Optocore is equipped by default with singlemode 1Gbit 10km transceiver.

The total optical loss should be less than 6dB between transceivers.

#### Please note:

SFP fiber transceivers are application specific and must match the coaxial interface

The user must not change internal SFP transceivers. Please refer to warnnaty conditions.

Please contact the BroaMan Technical Support team for further information.

### SANE Ports

Use standard, fully wired, twisted pair cable (Cat 5, Cat 5e, Cat 6) terminated with RJ-45 connectors. SANE utilizes all four pairs of the Cat 5 cable, two pairs for standard Ethernet transmission and two pairs for the SANE synchronous audio transport. A SANE cable shall not exceed a total cable distance of 100 m.

### Auxiliary Ports – RS485/GPIO/RS422

Each of the four (RS485)/eight (GPIO)/four dual RS422 channels requires a shielded twisted pair cable. If two or more channels are wired to the same cable a common braided shield should enclose the pairs.

### RS232 Connection

Use a standard shielded RS232 cable.

### Connector Hood Quality

Locking screws for D-Sub connectors should be compatible with 4-40 UNC. Care should be taken in selecting the right type of connector hoods in order to fulfil the requirements of EMI-radiation directives. Full metal connector hoods should be used, approved acc. to VDE 0871, FCC 20780 and EMC directive 2004/108/EG, providing attenuation > 40 dB between 30 MHz up to 1 GHz. The shield of the cable should have contact to the connector hood.

## BroaMan MUX22

Operating Manual

Rev. 2.1

### USB Connection

Use USB-A to USB-B cable between the PC and the device.

### LAN Connection

Use a standard twisted pair cable (Cat-5, Cat-6) with RJ-45 connectors.

### Word Clock/Sync Connection

Use 75  $\Omega$  coaxial cable with BNC connectors.

### Power Connection

Use power cords with IEC C13 connectors.

## Ordering Options

Below tables list the configurations available as a standard devices with unique ordering code. Please refer to the specific code when ordering.

BroaMan offers also custom versions of Mux22 with different I/O number, more fiber AUX channels and special connectivity. To specify custom device please contact [inquiry@broaman.com](mailto:inquiry@broaman.com).

### MUX22 IVT/IC422

Code	Description
M224442R515002PA1	Mux22-IVT/IC422 4 x 3G-SDI IN, 4 x 3G-SDI OUT, 4 x Clear-Com 4-wire Intercom, 2 x PSU, 1 x SM Optocore Link, 2 x SANE/LAN/MADI Cat5, 2 x LAN, 4 x RS485/422, 2 <sup>nd</sup> PSU, 1 x 1310nm Aux
M224442GP15002PA1	Mux22-IVT/IC422 4 x 3G-SDI IN, 4 x 3G-SDI OUT, 4 x Clear-Com 4-wire Intercom, 2 x PSU, 1 x SM Optocore Link, 2 x SANE/LAN/MADI Cat5, 2 x LAN, 4 x GPIO, 2 <sup>nd</sup> PSU, 1 x 1310nm Aux
M226242R515002PA1	Mux22-IVT/IC422 6 x 3G-SDI IN, 2 x 3G-SDI OUT, 4 x Clear-Com 4-wire Intercom, 2 x PSU, 1 x SM Optocore Link, 2 x SANE/LAN/MADI Cat5, 2 x LAN, 4 x RS485/422, 2 <sup>nd</sup> PSU, 1 x 1310nm Aux
M226242GP15002PA1	Mux22-IVT/IC422 6 x 3G-SDI IN, 2 x 3G-SDI OUT, 4 x Clear-Com 4-wire Intercom, 2 x PSU, 1 x SM Optocore Link, 2 x SANE/LAN/MADI Cat5, 2 x LAN, 4 x GPIO, 2 <sup>nd</sup> PSU, 1 x 1310nm Aux
M222642R515002PA1	Mux22-IVT/IC422 2 x 3G-SDI IN, 6 x 3G-SDI OUT, 4 x Clear-Com 4-wire Intercom, 2 x PSU, 1 x SM Optocore Link, 2 x SANE/LAN/MADI Cat5, 2 x LAN, 4 x RS485/422, 2 <sup>nd</sup> PSU, 1 x 1310nm Aux
M222642GP15002PA1	Mux22-IVT/IC422 2 x 3G-SDI IN, 6 x 3G-SDI OUT, 4 x Clear-Com 4-wire Intercom, 2 x PSU, 1 x SM Optocore Link, 2 x SANE/LAN/MADI Cat5, 2 x LAN, 4 x GPIO, 2 <sup>nd</sup> PSU, 1 x 1310nm Aux
M228042R515002PA1	Mux22-IVT/IC422 8 x 3G-SDI IN, 4 x Clear-Com 4-wire Intercom, 2 x PSU, 1 x SM Optocore Link, 2 x SANE/LAN/MADI Cat5, 2 x LAN, 4 x RS485/422, 2 <sup>nd</sup> PSU, 1 x 1310nm Aux
M228042GP15002PA1	Mux22-IVT/IC422 8 x 3G-SDI IN, 4 x Clear-Com 4-wire Intercom, 2 x PSU, 1 x SM Optocore Link, 2 x SANE/LAN/MADI Cat5, 2 x LAN, 4 x GPIO, 2 <sup>nd</sup> PSU, 1 x 1310nm Aux
M220842R515002PA1	Mux22-IVT/IC422 8 x 3G-SDI OUT, 4 x Clear-Com 4-wire Intercom, 2 x PSU, 1 x SM Optocore Link, 2 x SANE/LAN/MADI Cat5, 2 x LAN, 4 x RS485/422, 2 <sup>nd</sup> PSU, 1 x 1310nm Aux
M220842GP15002PA1	Mux22-IVT/IC422 8 x 3G-SDI OUT, 4 x Clear-Com 4-wire Intercom, 2 x PSU, 1 x SM Optocore Link, 2 x SANE/LAN/MADI Cat5, 2 x LAN, 4 x GPIO, 2 <sup>nd</sup> PSU, 1 x 1310nm Aux

## BroaMan MUX22

Operating Manual

Rev. 2.1

### MUX22 IVT/IC485

Code	Description
M224445R515002PA1	Mux22-IVT/IC485 4 x 3G-SDI IN, 4 x 3G-SDI OUT, 4 x RTS 4-wire Intercom, 2 x PSU, 1 x SM Optocore Link, 2 x SANE/LAN/MADI Cat5, 2 x LAN, 4 x RS485/422, 2 <sup>nd</sup> PSU, 1 x 1310nm Aux
M224445GP15002PA1	Mux22-IVT/IC485 4 x 3G-SDI IN, 4 x 3G-SDI OUT, 4 x RTS 4-wire Intercom, 2 x PSU, 1 x SM Optocore Link, 2 x SANE/LAN/MADI Cat5, 2 x LAN, 4 x GPIO, 2 <sup>nd</sup> PSU, 1 x 1310nm Aux
M226245R515002PA1	Mux22-IVT/IC485 6 x 3G-SDI IN, 2 x 3G-SDI OUT, 4 x RTS 4-wire Intercom, 2 x PSU, 1 x SM Optocore Link, 2 x SANE/LAN/MADI Cat5, 2 x LAN, 4 x RS485/422, 2 <sup>nd</sup> PSU, 1 x 1310nm Aux
M226245GP15002PA1	Mux22-IVT/IC485 6 x 3G-SDI IN, 2 x 3G-SDI OUT, 4 x RTS 4-wire Intercom, 2 x PSU, 1 x SM Optocore Link, 2 x SANE/LAN/MADI Cat5, 2 x LAN, 4 x GPIO, 2 <sup>nd</sup> PSU, 1 x 1310nm Aux
M222645R515002PA1	Mux22-IVT/IC485 2 x 3G-SDI IN, 6 x 3G-SDI OUT, 4 x RTS 4-wire Intercom, 2 x PSU, 1 x SM Optocore Link, 2 x SANE/LAN/MADI Cat5, 2 x LAN, 4 x RS485/422, 2 <sup>nd</sup> PSU, 1 x 1310nm Aux
M222645GP15002PA1	Mux22-IVT/IC485 2 x 3G-SDI IN, 6 x 3G-SDI OUT, 4 x RTS 4-wire Intercom, 2 x PSU, 1 x SM Optocore Link, 2 x SANE/LAN/MADI Cat5, 2 x LAN, 4 x GPIO, 2 <sup>nd</sup> PSU, 1 x 1310nm Aux
M228045R515002PA1	Mux22-IVT/IC485 8 x 3G-SDI IN, 4 x RTS 4-wire Intercom, 2 x PSU, 1 x SM Optocore Link, 2 x SANE/LAN/MADI Cat5, 2 x LAN, 4 x RS485/422, 2 <sup>nd</sup> PSU, 1 x 1310nm Aux
M228045GP15002PA1	Mux22-IVT/IC485 8 x 3G-SDI IN, 4 x RTS 4-wire Intercom, 2 x PSU, 1 x SM Optocore Link, 2 x SANE/LAN/MADI Cat5, 2 x LAN, 4 x GPIO, 2 <sup>nd</sup> PSU, 1 x 1310nm Aux
M220845R515002PA1	Mux22-IVT/IC485 8 x 3G-SDI OUT, 4 x RTS 4-wire Intercom, 2 x PSU, 1 x SM Optocore Link, 2 x SANE/LAN/MADI Cat5, 2 x LAN, 4 x RS485/422, 2 <sup>nd</sup> PSU, 1 x 1310nm Aux
M220845GP15002PA1	Mux22-IVT/IC485 8 x 3G-SDI OUT, 4 x RTS 4-wire Intercom, 2 x PSU, 1 x SM Optocore Link, 2 x SANE/LAN/MADI Cat5, 2 x LAN, 4 x GPIO, 2 <sup>nd</sup> PSU, 1 x 1310nm Aux

### MUX22 IVT/IC444

Code	Description
M224444R515002PA1	Mux22-IVT/IC444 4 x 3G-SDI IN, 4 x 3G-SDI OUT, 4 x Line In, 4 x Line Out, 4 x GPIO, 2 x PSU, 1 x SM Optocore Link, 2 x SANE/LAN/MADI Cat5, 2 x LAN, 4 x RS485/422, 2 <sup>nd</sup> PSU, 1 x 1310nm Aux
M224444GP15002PA1	Mux22-IVT/IC444 4 x 3G-SDI IN, 4 x 3G-SDI OUT, 4 x Line In, 4 x Line Out, 4 x GPIO, 2 x PSU, 1 x SM Optocore Link, 2 x SANE/LAN/MADI Cat5, 2 x LAN, 4 x GPIO, 2 <sup>nd</sup> PSU, 1 x 1310nm Aux
M226244R515002PA1	Mux22-IVT/IC444 6 x 3G-SDI IN, 2 x 3G-SDI OUT, 4 x Line In, 4 x Line Out, 4 x GPIO, 2 x PSU, 1 x SM Optocore Link, 2 x SANE/LAN/MADI Cat5, 2 x LAN, 4 x RS485/422, 2 <sup>nd</sup> PSU, 1 x 1310nm Aux
M226244GP15002PA1	Mux22-IVT/IC444 6 x 3G-SDI IN, 2 x 3G-SDI OUT, 4 x Line In, 4 x Line Out, 4 x GPIO, 2 x PSU, 1 x SM Optocore Link, 2 x SANE/LAN/MADI Cat5, 2 x LAN, 4 x GPIO, 2 <sup>nd</sup> PSU, 1 x 1310nm Aux
M222644R515002PA1	Mux22-IVT/IC444 2 x 3G-SDI IN, 6 x 3G-SDI OUT, 4 x Line In, 4 x Line Out, 4 x GPIO, 2 x PSU, 1 x SM Optocore Link, 2 x SANE/LAN/MADI Cat5, 2 x LAN, 4 x RS485/422, 2 <sup>nd</sup> PSU, 1 x 1310nm Aux
M222644GP15002PA1	Mux22-IVT/IC444 2 x 3G-SDI IN, 6 x 3G-SDI OUT, 4 x Line In, 4 x Line Out, 4 x GPIO, 2 x PSU, 1 x SM Optocore Link, 2 x SANE/LAN/MADI Cat5, 2 x LAN, 4 x GPIO, 2 <sup>nd</sup> PSU, 1 x 1310nm Aux
M228044R515002PA1	Mux22-IVT/IC444 8 x 3G-SDI IN, 4 x Line In, 4 x Line Out, 4 x GPIO, 2 x PSU, 1 x SM Optocore Link, 2 x SANE/LAN/MADI Cat5, 2 x LAN, 4 x RS485/422, 2 <sup>nd</sup> PSU, 1 x 1310nm Aux

## BroaMan MUX22

Operating Manual

Rev. 2.1

M228044GP15002PA1	Mux22-IVT/IC444 8 x 3G-SDI IN, 4 x Line In, 4 x Line Out, 4 x GPIO, 2 x PSU, 1 x SM Optocore Link, 2 x SANE/LAN/MADI Cat5, 2 x LAN, 4 x GPIO, 2 <sup>nd</sup> PSU, 1 x 1310nm Aux
M220844R515002PA1	Mux22-IVT/IC485 8 x 3G-SDI OUT, 4 x Line In, 4 x Line Out, 4 x GPIO, 2 x PSU, 1 x SM Optocore Link, 2 x SANE/LAN/MADI Cat5, 2 x LAN, 4 x RS485/422, 2 <sup>nd</sup> PSU, 1 x 1310nm Aux
M220844GP15002PA1	Mux22-IVT/IC485 8 x 3G-SDI OUT, 4 x Line In, 4 x Line Out, 4 x GPIO, 2 x PSU, 1 x SM Optocore Link, 2 x SANE/LAN/MADI Cat5, 2 x LAN, 4 x GPIO, 2 <sup>nd</sup> PSU, 1 x 1310nm Aux

### MUX22 IVT/ICAES

Code	Description
M2244AER515002PA1	Mux22-IVT/ICAES 4 x 3G-SDI IN, 4 x 3G-SDI OUT, 4 x AES3 Intercom, 2 x PSU, 1 x SM Optocore Link, 2 x SANE/LAN/MADI Cat5, 2 x LAN, 4 x RS485/422, 2 <sup>nd</sup> PSU, 1 x 1310nm Aux
M2244AEGP15002PA1	Mux22-IVT/ICAES 4 x 3G-SDI IN, 4 x 3G-SDI OUT, 4 x AES3 Intercom, 2 x PSU, 1 x SM Optocore Link, 2 x SANE/LAN/MADI Cat5, 2 x LAN, 4 x GPIO, 2 <sup>nd</sup> PSU, 1 x 1310nm Aux
M2262AER515002PA1	Mux22-IVT/ICAES 6 x 3G-SDI IN, 2 x 3G-SDI OUT, 4 x AES3 Intercom, 2 x PSU, 1 x SM Optocore Link, 2 x SANE/LAN/MADI Cat5, 2 x LAN, 4 x RS485/422, 2 <sup>nd</sup> PSU, 1 x 1310nm Aux
M2262AEGP15002PA1	Mux22-IVT/ICAES 6 x 3G-SDI IN, 2 x 3G-SDI OUT, 4 x AES3 Intercom, 2 x PSU, 1 x SM Optocore Link, 2 x SANE/LAN/MADI Cat5, 2 x LAN, 4 x GPIO, 2 <sup>nd</sup> PSU, 1 x 1310nm Aux
M2226AER515002PA1	Mux22-IVT/ICAES 2 x 3G-SDI IN, 6 x 3G-SDI OUT, 4 x AES3 Intercom, 2 x PSU, 1 x SM Optocore Link, 2 x SANE/LAN/MADI Cat5, 2 x LAN, 4 x RS485/422, 2 <sup>nd</sup> PSU, 1 x 1310nm Aux
M2226AEGP15002PA1	Mux22-IVT/ICAES 2 x 3G-SDI IN, 6 x 3G-SDI OUT, 4 x AES3 Intercom, 2 x PSU, 1 x SM Optocore Link, 2 x SANE/LAN/MADI Cat5, 2 x LAN, 4 x GPIO, 2 <sup>nd</sup> PSU, 1 x 1310nm Aux
M2280AER515002PA1	Mux22-IVT/ICAES 8 x 3G-SDI IN, 4 x AES3 Intercom, 2 x PSU, 1 x SM Optocore Link, 2 x SANE/LAN/MADI Cat5, 2 x LAN, 4 x RS485/422, 2 <sup>nd</sup> PSU, 1 x 1310nm Aux
M2280AEGP15002PA1	Mux22-IVT/IC485 8 x 3G-SDI IN, 4 x AES3 Intercom, 2 x PSU, 1 x SM Optocore Link, 2 x SANE/LAN/MADI Cat5, 2 x LAN, 4 x GPIO, 2 <sup>nd</sup> PSU, 1 x 1310nm Aux
M2208AER515002PA1	Mux22-IVT/ICAES 8 x 3G-SDI OUT, 4 x AES3 Intercom, 2 x PSU, 1 x SM Optocore Link, 2 x SANE/LAN/MADI Cat5, 2 x LAN, 4 x RS485/422, 2 <sup>nd</sup> PSU, 1 x 1310nm Aux
M2208AEGP15002PA1	Mux22-IVT/ICAES 8 x 3G-SDI OUT, 4 x AES3 Intercom, 2 x PSU, 1 x SM Optocore Link, 2 x SANE/LAN/MADI Cat5, 2 x LAN, 4 x GPIO, 2 <sup>nd</sup> PSU, 1 x 1310nm Aux

### MUX22 IVT/MADI-OPT

Code	Description
M2244MOR515002PA1	Mux22-IVT/MADI-OPT 4 x 3G-SDI IN, 4 x 3G-SDI OUT, 4 x duplex fiber MADI, 2 x PSU, 1 x SM Optocore Link, 2 x SANE/LAN/MADI Cat5, 2 x LAN, 4 x RS485/422, 2 <sup>nd</sup> PSU, 1 x 1310nm Aux
M2244MOGP15002PA1	Mux22-IVT/MADI-OPT 4 x 3G-SDI IN, 4 x 3G-SDI OUT, 4 x duplex fiber MADI, 2 x PSU, 1 x SM Optocore Link, 2 x SANE/LAN/MADI Cat5, 2 x LAN, 4 x GPIO, 2 <sup>nd</sup> PSU, 1 x 1310nm Aux
M2262MOR515002PA1	Mux22-IVT/MADI-OPT 6 x 3G-SDI IN, 2 x 3G-SDI OUT, 4 x duplex fiber MADI, 2 x PSU, 1 x SM Optocore Link, 2 x SANE/LAN/MADI Cat5, 2 x LAN, 4 x RS485/422, 2 <sup>nd</sup> PSU, 1 x 1310nm Aux
M2262MOGP15002PA1	Mux22-IVT/MADI-OPT 6 x 3G-SDI IN, 2 x 3G-SDI OUT, 4 x duplex fiber MADI, 2 x PSU, 1 x SM Optocore Link, 2 x SANE/LAN/MADI Cat5, 2 x LAN, 4 x GPIO, 2 <sup>nd</sup> PSU, 1 x 1310nm Aux

## BroaMan MUX22

Operating Manual

Rev. 2.1



M2226MOR515002PA1	Mux22-IVT/MADI-OPT 2 x 3G-SDI IN, 6 x 3G-SDI OUT, 4 x duplex fiber MADI, 2 x PSU, 1 x SM Optocore Link, 2 x SANE/LAN/MADI Cat5, 2 x LAN, 4 x RS485/422, 2 <sup>nd</sup> PSU, 1 x 1310nm Aux
M2226MOGP15002PA1	Mux22-IVT/MADI-OPT 2 x 3G-SDI IN, 6 x 3G-SDI OUT, 4 x duplex fiber MADI, 2 x PSU, 1 x SM Optocore Link, 2 x SANE/LAN/MADI Cat5, 2 x LAN, 4 x GPIO, 2 <sup>nd</sup> PSU, 1 x 1310nm Aux
M2280MOR515002PA1	Mux22-IVT/MADI-OPT 8 x 3G-SDI IN, 4 x duplex fiber MADI, 2 x PSU, 1 x SM Optocore Link, 2 x SANE/LAN/MADI Cat5, 2 x LAN, 4 x RS485/422, 2 <sup>nd</sup> PSU, 1 x 1310nm Aux
M2280MOGP15002PA1	Mux22-IVT/MADI-OPT 8 x 3G-SDI IN, 4 x duplex fiber MADI, 2 x PSU, 1 x SM Optocore Link, 2 x SANE/LAN/MADI Cat5, 2 x LAN, 4 x GPIO, 2 <sup>nd</sup> PSU, 1 x 1310nm Aux
M2208MOR515002PA1	Mux22-IVT/MADI-OPT 8 x 3G-SDI OUT, 4 x duplex fiber MADI, 2 x PSU, 1 x SM Optocore Link, 2 x SANE/LAN/MADI Cat5, 2 x LAN, 4 x RS485/422, 2 <sup>nd</sup> PSU, 1 x 1310nm Aux
M2208MOGP15002PA1	Mux22-IVT/MADI-OPT 8 x 3G-SDI OUT, 4 x duplex fiber MADI, 2 x PSU, 1 x SM Optocore Link, 2 x SANE/LAN/MADI Cat5, 2 x LAN, 4 x GPIO, 2 <sup>nd</sup> PSU, 1 x 1310nm Aux

### MUX22 IVT/MADI-BNC

Code	Description
M2244MCR515002PA1	Mux22-IVT/MADI-BNC 4 x 3G-SDI IN, 4 x 3G-SDI OUT, 4 x coax MADI I/O, 2 x PSU, 1 x SM Optocore Link, 2 x SANE/LAN/MADI Cat5, 2 x LAN, 4 x RS485/422, 2 <sup>nd</sup> PSU, 1 x 1310nm Aux
M2244MCGP15002PA1	Mux22-IVT/MADI-BNC 4 x 3G-SDI IN, 4 x 3G-SDI OUT, 4 x coax MADI I/O, 2 x PSU, 1 x SM Optocore Link, 2 x SANE/LAN/MADI Cat5, 2 x LAN, 4 x GPIO, 2 <sup>nd</sup> PSU, 1 x 1310nm Aux
M2262MCR515002PA1	Mux22-IVT/MADI-BNC 6 x 3G-SDI IN, 2 x 3G-SDI OUT, 4 x coax MADI I/O, 2 x PSU, 1 x SM Optocore Link, 2 x SANE/LAN/MADI Cat5, 2 x LAN, 4 x RS485/422, 2 <sup>nd</sup> PSU, 1 x 1310nm Aux
M2262MCGP15002PA1	Mux22-IVT/MADI-BNC 6 x 3G-SDI IN, 2 x 3G-SDI OUT, 4 x coax MADI I/O, 2 x PSU, 1 x SM Optocore Link, 2 x SANE/LAN/MADI Cat5, 2 x LAN, 4 x GPIO, 2 <sup>nd</sup> PSU, 1 x 1310nm Aux
M2226MCR515002PA1	Mux22-IVT/MADI-BNC 2 x 3G-SDI IN, 6 x 3G-SDI OUT, 4 x coax MADI I/O, 2 x PSU, 1 x SM Optocore Link, 2 x SANE/LAN/MADI Cat5, 2 x LAN, 4 x RS485/422, 2 <sup>nd</sup> PSU, 1 x 1310nm Aux
M2226MCGP15002PA1	Mux22-IVT/MADI-BNC 2 x 3G-SDI IN, 6 x 3G-SDI OUT, 4 x coax MADI I/O, 2 x PSU, 1 x SM Optocore Link, 2 x SANE/LAN/MADI Cat5, 2 x LAN, 4 x GPIO, 2 <sup>nd</sup> PSU, 1 x 1310nm Aux
M2280MCR515002PA1	Mux22-IVT/MADI-BNC 8 x 3G-SDI IN, 4 x coax MADI I/O, 2 x PSU, 1 x SM Optocore Link, 2 x SANE/LAN/MADI Cat5, 2 x LAN, 4 x RS485/422, 2 <sup>nd</sup> PSU, 1 x 1310nm Aux
M2280MCGP15002PA1	Mux22-IVT/MADI-BNC 8 x 3G-SDI IN, 4 x coax MADI I/O, 2 x PSU, 1 x SM Optocore Link, 2 x SANE/LAN/MADI Cat5, 2 x LAN, 4 x GPIO, 2 <sup>nd</sup> PSU, 1 x 1310nm Aux
M2208MCR515002PA1	Mux22-IVT/MADI-BNC 8 x 3G-SDI OUT, 4 x coax MADI I/O, 2 x PSU, 1 x SM Optocore Link, 2 x SANE/LAN/MADI Cat5, 2 x LAN, 4 x RS485/422, 2 <sup>nd</sup> PSU, 1 x 1310nm Aux
M2208MCGP15002PA1	Mux22-IVT/MADI-BNC 8 x 3G-SDI OUT, 4 x coax MADI I/O, 2 x PSU, 1 x SM Optocore Link, 2 x SANE/LAN/MADI Cat5, 2 x LAN, 4 x GPIO, 2 <sup>nd</sup> PSU, 1 x 1310nm Aux

## BroaMan MUX22

Operating Manual

Rev. 2.1

## Connector Pin Out

Pin-out		Four-Wire Intercom port - TO PANEL – ClearCom (IC422)				
Channel	+	Audio In	Audio Out	RS422 In	RS422 Out	Use this pin-out only for devices loaded with ClearCom modules (IC422)
	Pin	3	4	1	7	
Pin	-	6	5	2	8	
RJ-45						

Pin-out		Four-Wire Intercom port - TO MATRIX – ClearCom (IC422)				
Channel	+	Audio In	Audio Out	RS422 In	RS422 Out	Use this pin-out only for devices loaded with ClearCom modules (IC422)
	Pin	4	3	7	1	
Pin	-	5	6	8	2	
RJ-45						

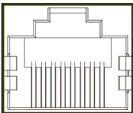
Pin-out		Four-Wire Intercom port - TO PANEL – RTS / Telex (IC485)				
Channel	+	Audio In	Audio Out	RS485*	Use this pin-out only for devices loaded with RTS / Telex modules (IC485) * Shows the standard pin out for RS485 on the IC485 module. Other pin outs may be specified at the time of order.	
	Pin	4	3	7		
Pin	-	5	6	2		
RJ-45				 <p>7 5 3 1 8 6 4 2</p> <p>RJ45 is physically compatible with RJ11 and RJ12 connectors commonly used for RTS/Telex panels and matrices.</p>		

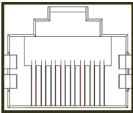
Pin-out		Four-Wire Intercom port - TO MATRIX - RTS / Telex (IC485)				
Channel	+	Audio In	Audio Out	RS485	Use this pin-out only for devices loaded with RTS / Telex modules (IC485) * Shows the standard pin out for RS485 on the IC485 module. Other pin outs may be specified at the time of order.	
	Pin	3	4	7		
Pin	-	6	5	2		
RJ-45				 <p>7 5 3 1 8 6 4 2</p> <p>RJ45 is physically compatible with RJ11 and RJ12 connectors commonly used for RTS/Telex panels and matrices.</p>		

## BroaMan MUX22

Operating Manual  
Rev. 2.1

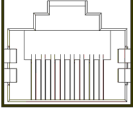
Pin-out					Four-Wire AES port - TO PANEL – AES based intercom systems (ICAES)				
		Channel	TX	RX	Use this pin-out only for devices loaded with AES modules (ICAES)				
Pin	+		3	1					
	-		6	2					
RJ-45					 7 5 3 1 8 6 4 2				

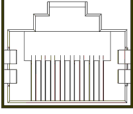
Pin-out					Four-Wire AES port – TO MATRIX – AES based intercom systems (ICAES)				
		Channel	TX	RX	Use this pin-out only for devices loaded with AES modules (ICAES)				
Pin	+		1	3					
	-		2	6					
RJ-45					 7 5 3 1 8 6 4 2				

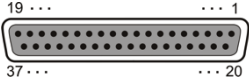
Pin-out					Line Level Inputs / General Purpose Inputs (IC444)							
		Line Level Input				General Purpose Input				Aux. Power		
		1	2	3	4		1	2	3	4	+5V	+12V
Pin	+	21	23	25	27	+	29	31	33	35	19	37
	-	3	5	7	9	-	11	13	15	17	-	-
	GND	22	24	26	28	GND	30	32	34	36	-	-
D-Sub-37- female		 19 ... ... 1 37 ... ... 20				Locking system acc. to 4-40 UNC						

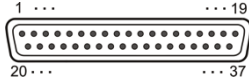
Pin-out					Line Level Outputs / General Purpose Outputs (IC444)							
		Line Level Output				General Purpose Output				Aux. Power		
		1	2	3	4		1	2	3	4	+5V	+12V
Pin	+	21	23	25	27	NC	29	31	33	35	19	37
	-	3	5	7	9	NO	11	13	15	17	-	
	GND	22	24	26	28	COM	30	32	34	36	-	
D-Sub-37- male		 1 ... ... 19 20 ... ... 37				Locking system acc. to 4-40 UNC						

## BroaMan MUX22

Operating Manual  
Rev. 2.1

Pin-out		Auxiliary Port - 4 x RS485					
	Channel	RS485				GND	Please verify the correct polarity of adaptors.  Software configurable for duplex (RS485) or simplex (RS422) operation.  An adaptor must be constructed for connectivity to MIDI or CAN interfaces.
		1	2	3	4		
Pin	+	1	2	3	4	5	
	-	6	7	8	9		
D-Sub-9- female						Locking system acc. to 4-40 UNC	

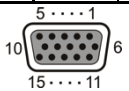
Pin-out		Auxiliary Port - 4 x GPIO									
	Channel	GPI				GPO				GND	Electro Isolated.  Available as a factory fitted replacement option for the serial ports.
		1	2	3	4	1	2	3	4		
Pin	+	3	6	10	13	1	4	11	14	7, 8, 9	
	-	GND	GND	GND	GND	2	5	12	15		
HD-Sub-15- female										Locking system acc. to 4-40 UNC	

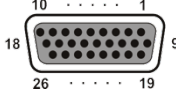
Pin-out		Auxiliary Port - 4 x Dual RS422									
	Channel	RS422 Input (RX)				RS422 Output (TX)				GND	Software configurable for duplex (RS485) operation.  Available as a factory fitted replacement option for the serial ports.
		1	2	3	4	1	2	3	4		
Pin	+	1	3	5	7	19	21	23	25	10, 11, 12, 13, 14, 15, 16, 17, 18	
	-	2	4	6	8	20	22	24	26		
HD-SUB-26 female											

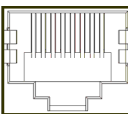
Pin-out		SANE - Synchronous Audio and Ethernet					
	Pin	SANE / MADI RX	SANE / MADI TX	Ethernet RX	Ethernet TX	A device compatible with 10/100MB Fast Ethernet can be connected to a SANE port for Ethernet data communication.	
		+	7	4	3		1
	Pin	-	8	5	6		2
RJ-45							

## BroaMan MUX22

Operating Manual  
Rev. 2.1

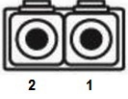
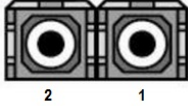
Pin-out		Optical Fiber-Port						
		Optocore		SDI*		MADI		* Assumes standard Input / Output transceiver. Non-standard Input / Input and Output / Output transceivers for SDI video I/O are available
		TXD	RXD	TXD	RXD	TXD	RXD	
	Pin	2	1	2	1	2	1	
LC and SC connectors								

Pin-out		RS232 - Port						
	Channel	RS232		Internally bridged		Power		Use standard RS232 cable, male – female, to connect to PC
		RXD	TXD			+5VS	GND	
	Pin	3	2	1, 4, 6	7, 8	9	5	
D-Sub-9- female					Locking system acc. to 4-40 UNC			

Pin-out		USB - Port				
	Channel	USB			GND	USB B – device connector
		VBUS	D -	D +		
	Pin	1	2	3	4	

Pin-out		DC Input – Factory Fitted Option		
		12V	GND	
	Pin	+	4	1
XLR 4 Pin male				

## BroaMan MUX22

Operating Manual  
Rev. 2.1

## Connection Examples GPI/GPO IC444 Module

### D-Sub 37-Pin female IC444-module Line In / GPI

**Auxiliary Power**  
Pin 19: +5V DC  
Pin 37: +12V DC  
≤100mA/IC444 module

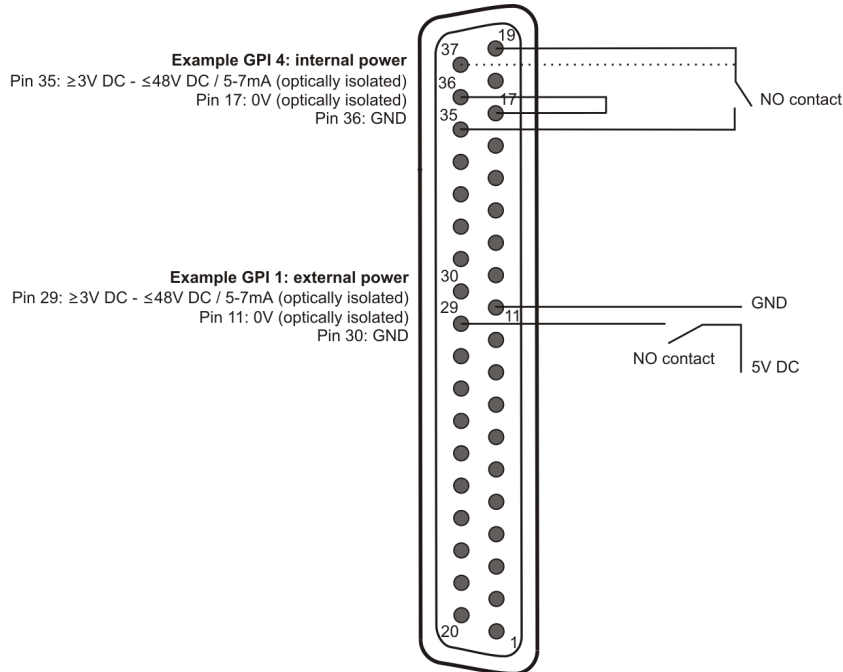

### D-Sub 37-Pin male IC444-module Line Out / GPO

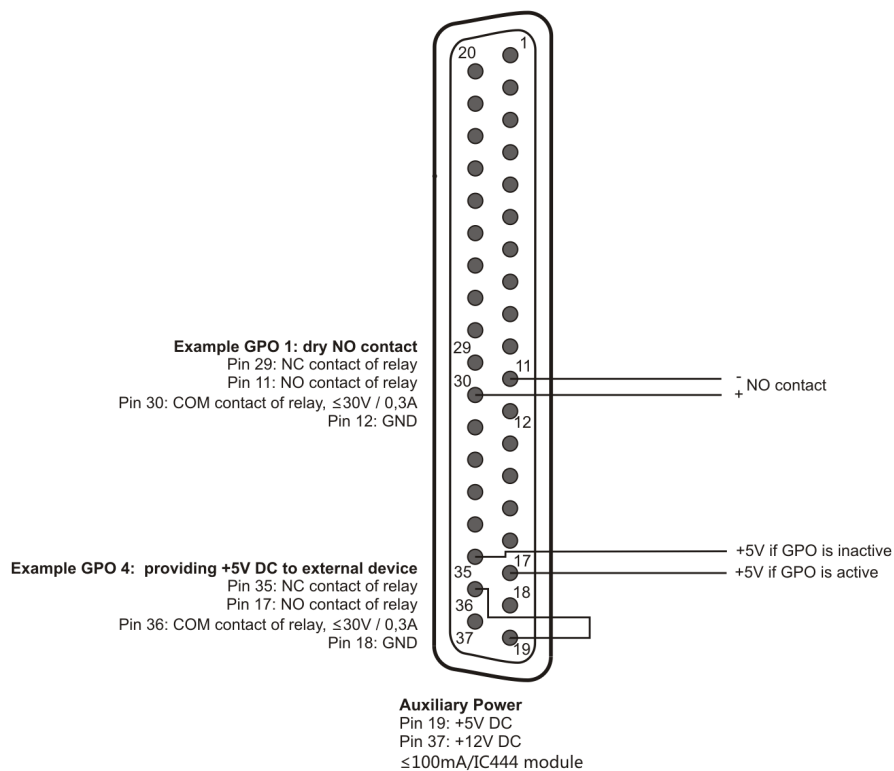

## Technical Specifications

<b>Video</b>		
<b>Standards</b>	SD, ED, HD, Dual Link, 3G	
<b>Complies with SMPTE</b>	259M, 292M, 344M, 372M, 424M	
<b>Interface</b>	SDI – Serial Digital Interface	
<b>Optical Connection</b> Complies with 21 CFR 1040.10 and 1040.11		
<b>SANE, LAN</b> Convention		
<b>Audio</b>	TIA - 568A/B, Optocore	200 Mbit/s
<b>LAN</b>	TIA - 568A/B, IEEE - 802.3	10/100 Mbit/s
<b>Word clock/Sync</b> Hardware standard BNC - 75 $\Omega$		
<b>Data rate</b>	Depending on selected sample rate	Up to 192 kHz
<b>Impedance</b>	Output	$\leq 5 \Omega$
	Input	75 $\Omega$
<b>Drive level</b>	Output	$\geq 1 V_{pp}$
<b>Zero level</b>	Referring to GND	+ 1.7 V
<b>Sense level</b>	Input	$\geq 400 mV_{pp}$
<b>Remote Control</b> Convention		
<b>RS232</b>	EIA / TIA - 232	57 600 Baud
<b>USB</b>	USB 2.0 - Device	12 Mbit/s
<b>LAN</b>	IEEE - 802.3	10/100 Mbit/s
<b>Power supply</b>		
<b>Type</b>	Switch-mode, universal input	
<b>Mains voltage</b>	100 ... 240 V	
<b>Frequency</b>	50 ... 60 Hz	
<b>Power consumption</b>	Depending on the configuration of the device, 32VA - Max	
<b>Security classification</b>	Class 1: basic insulation, connected to the protective grounding conductor	
<b>Security regulations</b>	Harmonised European standard EN60065	
<b>Mains connector</b>	Acc. to IEC-950	
<b>Cooling</b>	Passive, via surface and ventilation-slits on both sides	

## BroaMan MUX22

Operating Manual  
Rev. 2.1

## Dimensions and Weight

### Dimensions

Front panel:	width	483 mm / 19 inch
	height	44 mm / 1.73 inch
	depth	200 mm / 7.87 inch
Rear panel:	width	438 mm / 17.25 inch

### Weight

Dependent on the configuration of each specific device. Not more than 3kg.

**Please note:**

Modifications that serve the purpose of technical improvement may be carried out without prior notification.



## Warranty and Liability

### Summary of Warranty

Broaman Mux22 device is warranted against defects in material and workmanship for 60 months (5 years) from the date of purchase. This warranty does not include mechanical damages caused by misuse. This warranty covers the original registered purchaser only and is not transferable. This warranty does not apply to devices which have been purchased in used condition or demonstrator equipment.

BROAMAN will, at its discretion, repair or replace a defective product, providing that the defect has occurred under normal operating conditions.

This warranty does not cover damage from acts of God, accident, abuse, neglect, contamination, unauthorised modification, misuse, or operation outside of the environmental specifications for the product, improper site preparation or maintenance, or abnormal conditions of handling. This would include over-voltage failures, and conditions outside of the products specified ratings, problems with customer-supplied software or interfacing, or normal wear and tear of mechanical components. BROAMAN will acknowledge the evaluation of warranty after inspection.

Not covered by this warranty are defects arising from electromagnetic or electrical interferences, deficiency, excess, or surge of electrical supply, air conditioning, or humidity. This also includes repairs made necessary by dirt, abrasion, moisture, rust, corrosion, or similar conditions.

Devices on which the Serial Number has been removed or defaced are not eligible for warranty service.

BROAMAN devices contain no user-serviceable components: refer to qualified service personnel for repair or upgrade. The warranty will be void if you tamper with internal components. Please address any questions or inquiries to BROAMAN or your distributor/dealer.

For a full warranty conditions refer to the Warranty Card attached to every Broaman device with a first shipment.

### How to Obtain Warranty Service

When discovering a problem with an BROAMAN device, you should contact either Broaman directly or a dealer/distributor to determine and confirm a hardware fault. If it is a software issue the hardware must not be returned to BROAMAN, BROAMAN will issue a support ticket in this case.

If hardware service is required within the warranty period, take the equipment, along with warranty card, to the nearest authorised BROAMAN dealer/distributor. The dealer/distributor will make sure that the device is serviced according to the terms of warranty by BROAMAN or an authorised service centre.

If the equipment needs to be returned directly to BROAMAN, first contact [support@broaman.com](mailto:support@broaman.com).

BROAMAN requires the serial number of the equipment intended for return, as well as a short description of the problem. If possible, you should also provide us a phone number where you can be reached during regular working hours. To return a defective product, please contact your distributor / dealer. Our web site: <http://www.broaman.com/> provides a complete list of Broaman distributors / dealers.

Make sure the equipment being returned is packed carefully to protect it from damage during shipment. BROAMAN requires that shipments are pre-paid and insured – unless specifically authorized in advance.

We strongly advise not to use simple flight-cases without rack-in-rack mounting.

### Declaration of Liability

Broaman accepts no liability for damage caused to other devices through operation of the Mux22 device.

Broaman is not liable for any damage caused by shipping accidents, misuse, abuse, operation with incorrect AC voltage, operation with faulty peripheral equipment, or improper or careless installation of the device.

Neither BROAMAN nor anyone involved in the production of the equipment shall be liable for any indirect, special, disciplinary, consequential, or incidental damages arising out of the use or inability to use this equipment even if BROAMAN has been advised of the possibility of such damages. In no event shall the liability of BROAMAN exceed the purchase price of any defective equipment. *Broaman accepts no claims for compensation whatsoever (e.g. cancellation of events).*

## Broaman MUX22

Operating Manual

Rev. 2.1

## **Package Contents**

MUX22 is a part of the ordered system. Each MUX22 package should consist of:

- 1 MUX22 unit
- 1 LC-LC 0.25m fibre patch cable
- 2 power cables

Any additionally purchased equipment such as optical fiber cables in required lengths, D-Sub cables and adapters, RS232 cables, and international electric cables, which have been supplied on your request and your purchase order, cannot be listed above.

Please note that due to the Ecology reason standard shipment **does not** contain printed copy of User Manual. All latest BROAMAN user manuals can be downloaded from the website:

<http://www.broadcastmanufactur.com/index.php/support-downloads>

Printed version of User Manual is available on a special demand. Please contact [support@broaman.com](mailto:support@broaman.com) if printed version is required.

## **Company Information**

### **Mailing Address:**

BROAMAN GmbH  
Lohenstr. 8  
D-82166 Munich-Gräfelfing  
Germany

### **Telephone:**

+49 – (0)89 – 89996460

### **Facsimile:**

+49 – (0)89 – 89996479

### **Internet:**

[www.BroaMan.com](http://www.BroaMan.com)

### **Email:**

[inquiry@broaman.com](mailto:inquiry@broaman.com)

## **BroaMan MUX22**

Operating Manual  
Rev. 2.1